

## Quick Reference Guide

Accurate probe tip measurements on wafers and planar circuits require accurate system calibration to the probe tip end. Calibration eliminates systematic measurement errors caused by the imperfection of the measurement instrument and system accessories (cables, connectors, probe tips, etc.). The quality of calibration significantly depends on the accuracy of calibration standards. Calibration substrates contain precise standards providing an exact system calibration over a wide frequency range.

The |Z| Probe and the CSR family of calibration substrates are developed jointly with Rosenberger Hochfrequenztechnik (www.rosenberger.de), a worldwide leading manufacturer of high-frequency coaxial connectors and accessories with over 30 years of experience in the RF and microwave industry.

---

### Benefits

---

- Laser trimmed LOAD resistor, unique accuracy
  - Supports SOLT and LRM methods
  - Special alignment elements for all standards
  - Four non-dispersive standard types: LOAD, OPEN, SHORT, THRU/LINE
  - Suitable for 400-600  $\mu\text{m}$  pitches
  - GSSG footprints
- 

### Characteristics

---

Material	Alumina
Size	20.3 x 22.6 mm
Thickness	635 $\mu\text{m}$
Dielectric Constant	$\epsilon = 10.2$
Effective Permittivity	5.73
Effective Velocity	0.43
Phase Velocity	7.36 ps/m
THRU Impedance	nominally 50 $\Omega$
DC accuracy (LOAD)	50 $\Omega$ +/- 0.15 Ohm (< 0.3 %)
Temperature drift	< 0.3 % between $-263^{\circ}\text{C}$ ... $+150^{\circ}\text{C}$
Maximum Power	0.3 W

---

## Substrate Elements

### Standard Name

Each standard on the substrate has a unique name that is used to address it on the substrate standards map. Each standard has an index number indicating the row and the column of the standard's location.

### Standard Type

Standards on a substrate are divided into two groups: transmission and reflection elements.

The reflection elements include OPEN, SHORT and LOAD standards. When calibrating a system, these elements are used to provide different reflection factors: fully matched (for Load) or highly reflective (for Open and Short).



#### NOTE

*There are two different SHORT types available: standard (slotted) for calibrations up to 10 GHz and broadband for higher frequencies.*

---

Transmission elements are the THRU and LINE standards. They are used for measurements of transmission parameters, providing a physical connection between at least two ports of the system. The electrical length of a transmission element is defined in pico-seconds. THRU standards are the shortest lines on the substrate. The length of the THRU standard is equal

# CSR-44 Calibration Substrate

to the spacing of all reflective standards. LINE standards are the longer transmission elements and used as LINE for TRL calibration or verification purposes.

## Standard Ports

A standard on the calibration substrate consists of four elements that form a pair. This layout is determined to reduce the calibration time and movement on the substrate with high accuracy measurement. This pair contains four elements formed from the same type. CSR-44 is designed for four-port calibration by using two GSSG probes.

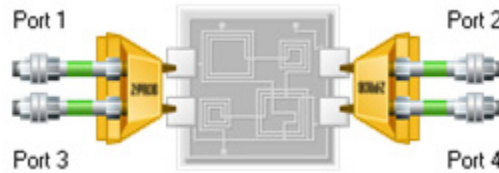

Figure 1. Four-port configuration

## Location

A map of the standards' locations is defined to enable automated positioning of the probes on the substrate via calibration software. These locations are defined in (X, Y) coordinates in microns according to a specific reference element which has the reference position (0,0). CSR-44 has individual reference elements for OPEN, SHORT, LOAD, THRU (0,0) and LINE elements to align the different distances without touching the standards.

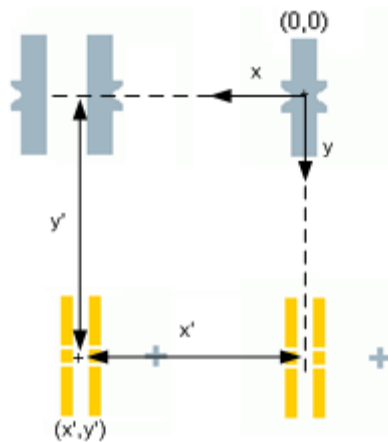

Figure 2. Reference standard defines the location of an open standard

## Probe Spacing and Length of Standards

The distance between probe tips in contact position with the substrate defines the probe spacing in Figure 3. The double align standards are used to define the different probe spacing for LINE elements. There is an individual reference element for each line to ensure accurate calibration. See Figure 4.

# CSR-44 Calibration Substrate

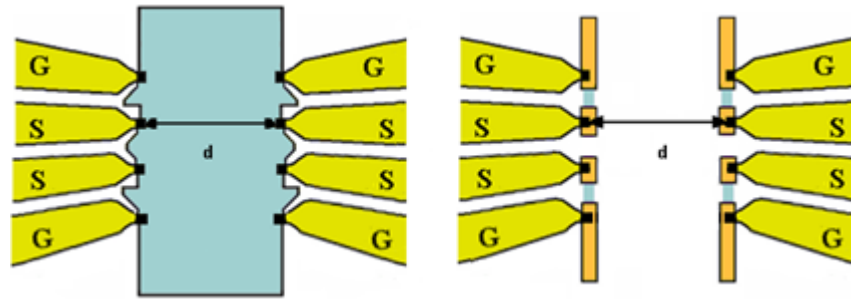

Figure 3. Probe spacing

The electrical length of a LINE standard is defined by the propagation delay time in (ps), which describes the propagation delay for the transmission between two probe tips. This value is calculated from the probe spacing for the transmission elements and the effective velocity of light.

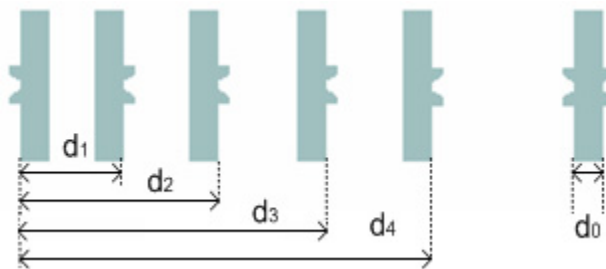

Figure 4. Different references for different lengths on the substrate

## Recommended Probes and Standard Models

Calibration Substrate CSR-44 can be used with RF probes with pitches from 400 to 600  $\mu\text{m}$  and a GSSG footprint. The IZI Probes are recommended to achieve the best measurement accuracy.

Measured values from the calibration substrate include parasitic effects associated with the standards. In order to make the calibration independent of these effects, a simulation of the electric field patterns of the probe touching the standard is done. The results are called correction values. By using these correction values delivered with each IZI Probe, it is possible to set the calibration plane accurately at the end of the tips. The calibration coefficients delivered with the probes are parallel capacitance for the OPEN, series inductance for SHORT and series inductance for LOAD. These values must be entered into the VNA before manual calibration. Using calibration software, these values are adjusted automatically.

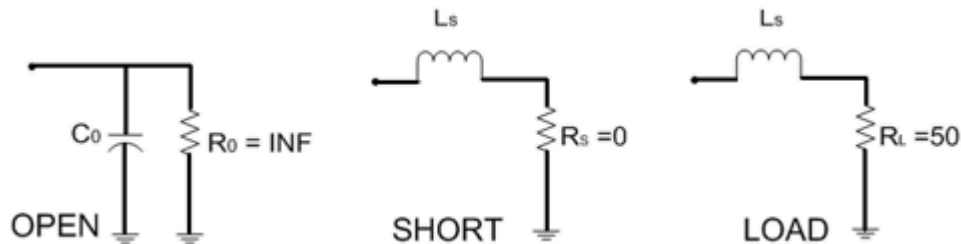
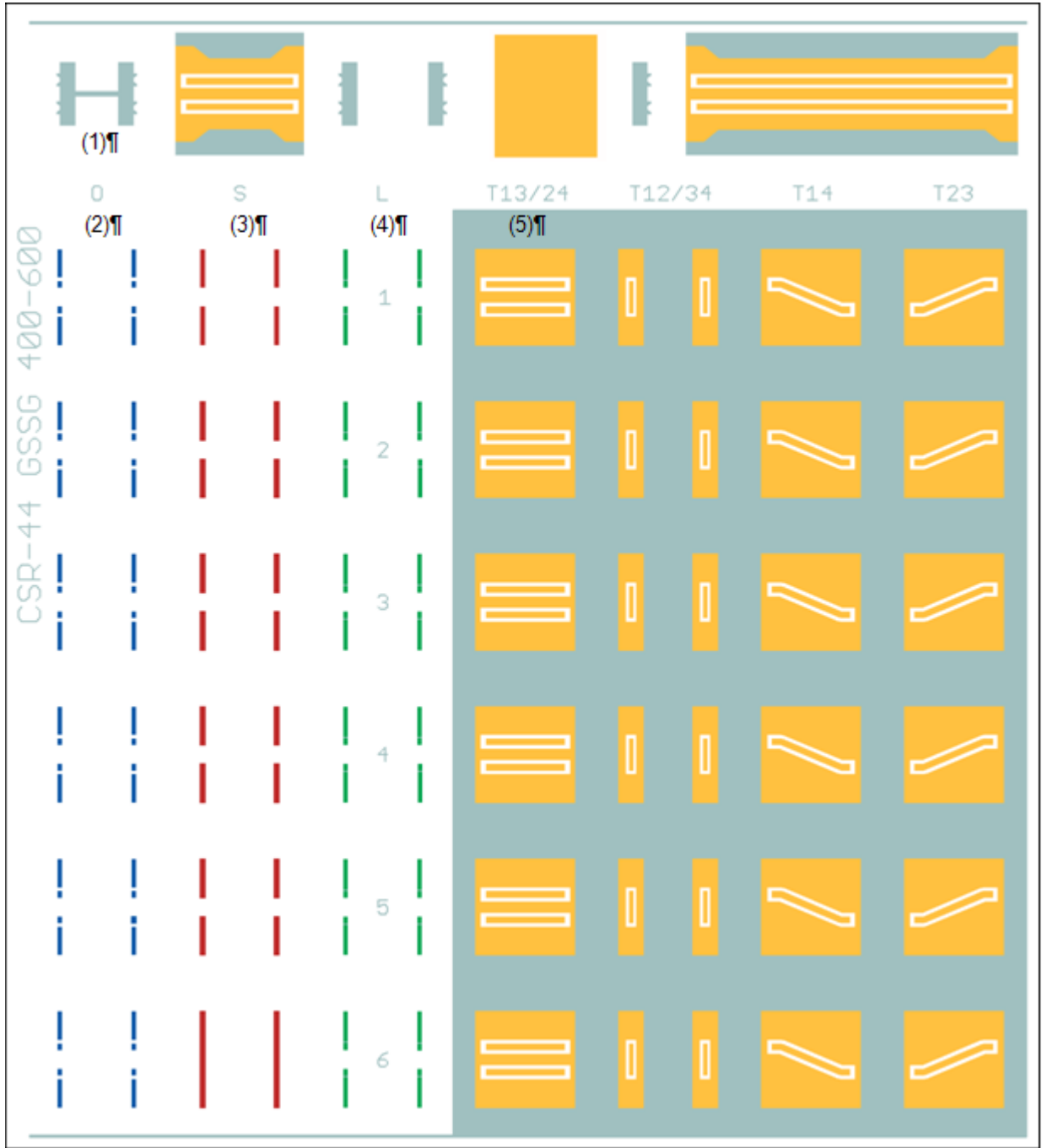

Figure 5. Parasitic elements

# CSR-44 Calibration Substrate

## Substrate Layout



20.3 x 22.6 mm



# CSR-44 Calibration Substrate

## Loads Specification

The LOAD standards are laser trimmed thin-film resistors, specified at 50Ω with certain accuracy. The LOAD standard consists of a pair of resistances, where each is an equivalent resistance of two parallel resistances. The standard and its electrical model is found below, where Table 1 includes the values of the resistances and their tolerances. Due to fabrication, one of the LOAD standards may not be present on the substrate.

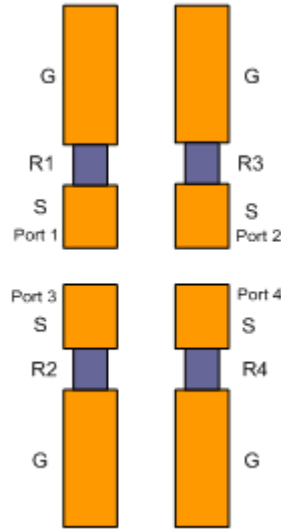

Figure 6. Standard model

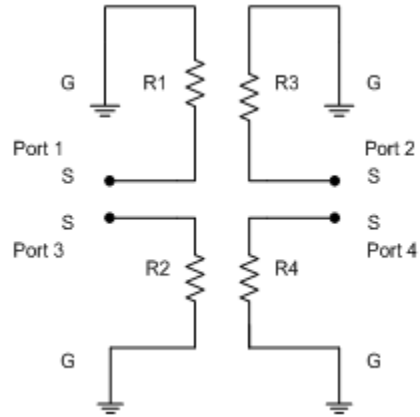

Figure 7. Electrical model

Table 1. Load resistances and Tolerances

Substrate ID:								
Number	Port 1	Deviation	Port 2	Deviation	Port 3	Deviation	Port 4	Deviation
	R1		R2		R3		R4	
12								
22								
32								
42								
52								
62								

# CSR-44 Calibration Substrate

---

## Notice of Normal Use

The statements, technical information and recommendations contained herein are believed to be accurate as of the date hereof. Information in this document is subject to change without notice. The user has the responsibility to read and follow carefully all safety and use instructions. Since the conditions and methods of use of the product and of the information referred to herein are beyond our control, Cascade Microtech, Inc. expressly disclaims any and all liability as to any results obtained or arising from any use of the product or reliance on such information; NO WARRANTY OF FITNESS FOR ANY PARTICULAR PURPOSE, WARRANTY OF MERCHANTABILITY OR ANY OTHER WARRANTY, EXPRESS OR IMPLIED, IS MADE CONCERNING THE GOODS DESCRIBED OR THE INFORMATION PROVIDED HEREIN.

The information provided herein relates only to the specific product designated and may not be applicable when such product is used in combination with other materials or in any process. The user assumes all liability for misuse or alteration of the product, or for use in any manner not described in the Cascade Microtech, Inc. documentation.

Nothing contained herein constitutes a license to practice under any patent and it should not be construed as an inducement to infringe any patent and the user is advised to take appropriate steps to be sure that any proposed use of the product will not result in patent infringement.

© Copyright 2016 Cascade Microtech, Inc.  
All rights reserved. Cascade Microtech and IZI Probe are registered trademarks of Cascade Microtech, Inc. All other trademarks are the pr

Data subject to change without notice.

**Cascade Microtech, Inc.**  
**Corporate Headquarters**  
toll free: +1-800-550-3279  
phone: +1-503-601-1000  
email: [cmi\\_sales@cmicro.com](mailto:cmi_sales@cmicro.com)

**Germany**  
phone: +49-35240-73-333  
email: [cmg\\_sales@cmicro.com](mailto:cmg_sales@cmicro.com)

**Japan**  
phone: +81-3-5615-5150  
email: [cmj\\_sales@cmicro.com](mailto:cmj_sales@cmicro.com)

**China**  
phone: +86-21-3330-3188  
email: [cmc\\_sales@cmicro.com](mailto:cmc_sales@cmicro.com)

**Singapore**  
phone: +65-6873-7482  
email: [cms\\_sales@cmicro.com](mailto:cms_sales@cmicro.com)

**Taiwan**  
phone: +886-3-5722810  
email: [cmt\\_sales@cmicro.com](mailto:cmt_sales@cmicro.com)

